

Airborne Isolated 3-Phase PFC Module

115 VrmsL-N Input Voltage	45 Hz to 800 Hz Input Frequency	4250 Vdc Isolation	48 Vdc Output Voltage	720 W Output Power	100 °C Baseplate Temp	>0.99 PF	1.5% THD	92.0% Full Load Efficiency
-------------------------------------	---	------------------------------	---------------------------------	------------------------------	---------------------------------	-----------------------	--------------------	--------------------------------------



The AeroQor® 3-Phase Isolated PFC Module is a high efficiency, active PFC, AC-DC converter designed to be used as a COTS Component in airborne applications. It operates from a 115 Vrms AC input and generates an isolated DC output. Regulated and droop output modules are available. Used in conjunction with a SynQor's AC line filter, the pair will draw a nearly perfect sinusoidal current (PF>0.99) from a 3-Phase AC input.



Designed and manufactured in the USA

Operational Features

- Compatible with commercial aircraft 60 Hz, 400 Hz & var. freq. systems
- Harmonic content meets commercial aircraft standards
- Minimal inrush current
- Balanced phase currents
- High power factor (0.99 at 400 Hz / 720 W)
- Minimal external output capacitance requirement
- Full load current during startup
- Ability to meet full EMI with available additional EMI filters
- N * 720 W power levels when paralleled

Control Features

- All control pins referenced to separate floating return
- Asynchronous serial data interface
- AC and DC Power Good outputs
- PFC Enable input
- 3.3 V always-on standby power output
- Clock synchronization output

Protection Features

- Output current limit and auto-recovery short circuit protection
- Auto-recovery input under/over-voltage protection
- Auto-recovery output over-voltage protection
- Auto-recovery thermal shutdown

Mechanical Features

- Industry standard Full-brick-size
- Size: 2.486" x 4.686" x 0.512" (63.14 x 119.02 x 13.0 mm)
- Weight: 11.3 oz (320 g)

Specification Compliance

- RTCA/DO-160G
- Airbus ABD0100.1.8
- Boeing 787B3-0147
- Boeing D6-36440
- Boeing D6-44588
- CE Marked

Contents

	Page No.
Typical Applications	2
Technical Specification	4
Standards & Qualification	6
Application Section	7
Encased Mechanical	18
Ordering Information	20



Typical Application

APFIC-115-3PH-48x-FT
Input: 115Vrms_{LN} 3Φ
Output: 48 Vdc
Power: 720 W

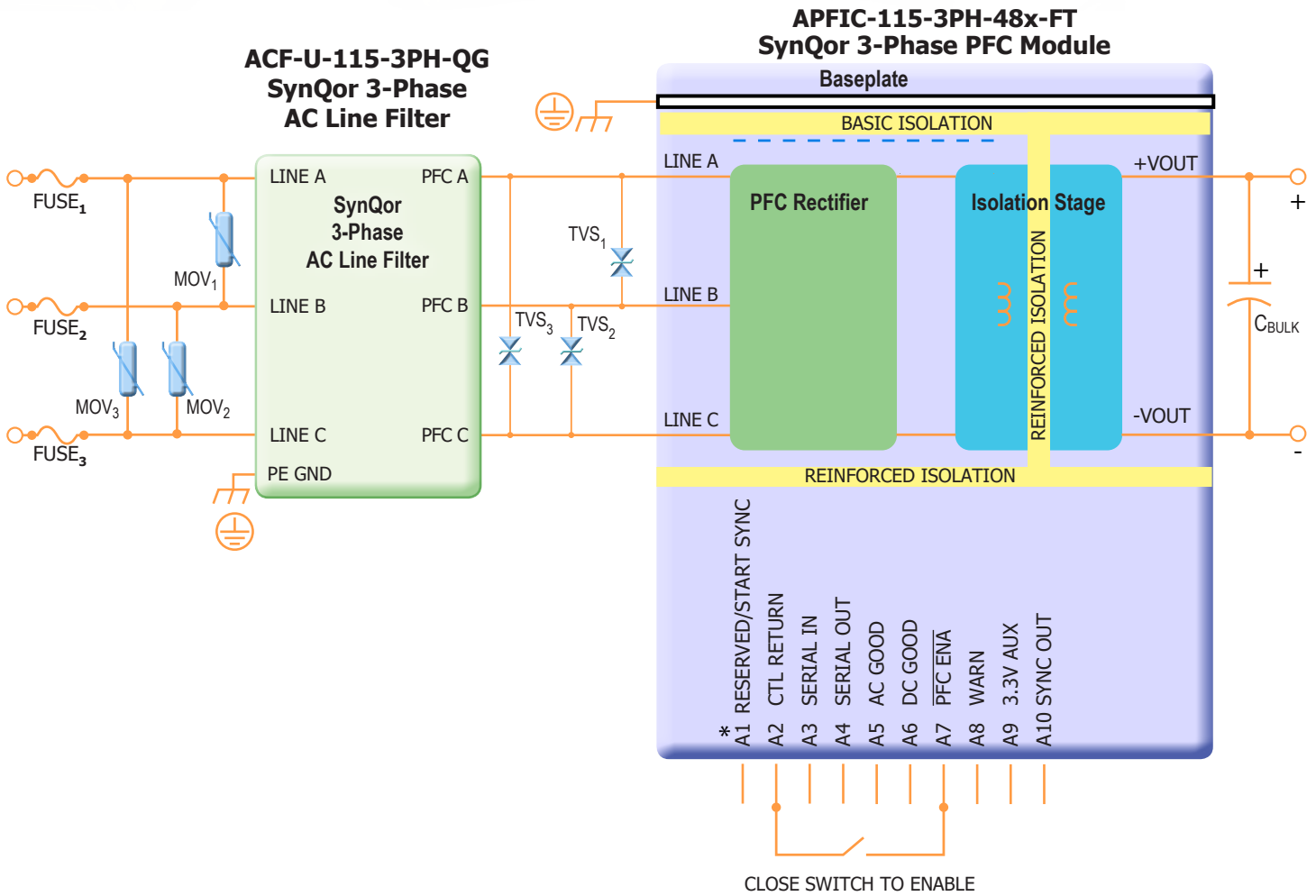

* Note A1 RESERVED for Regulated Module
 START SYNC for Droop Module

Suggested Parts:

MOV₁₋₃ : 300 Vrms, 60 J; EPCOS S10K300E2

TVS₁₋₃ : 430 Vpk, 20 J; Littelfuse AK3-430C or Bourns PTVS-430C-TH

Fuse₁₋₃ : 250 Vrms, 10 A; Littelfuse 0216010.XEP

Figure A: Typical application of the AeroQor Isolated PFC module



Typical Application

APFIC-115-3PH-48x-FT
Input: 115Vrms_{L-N} 3Φ
Output: 48 Vdc
Power: 720 W

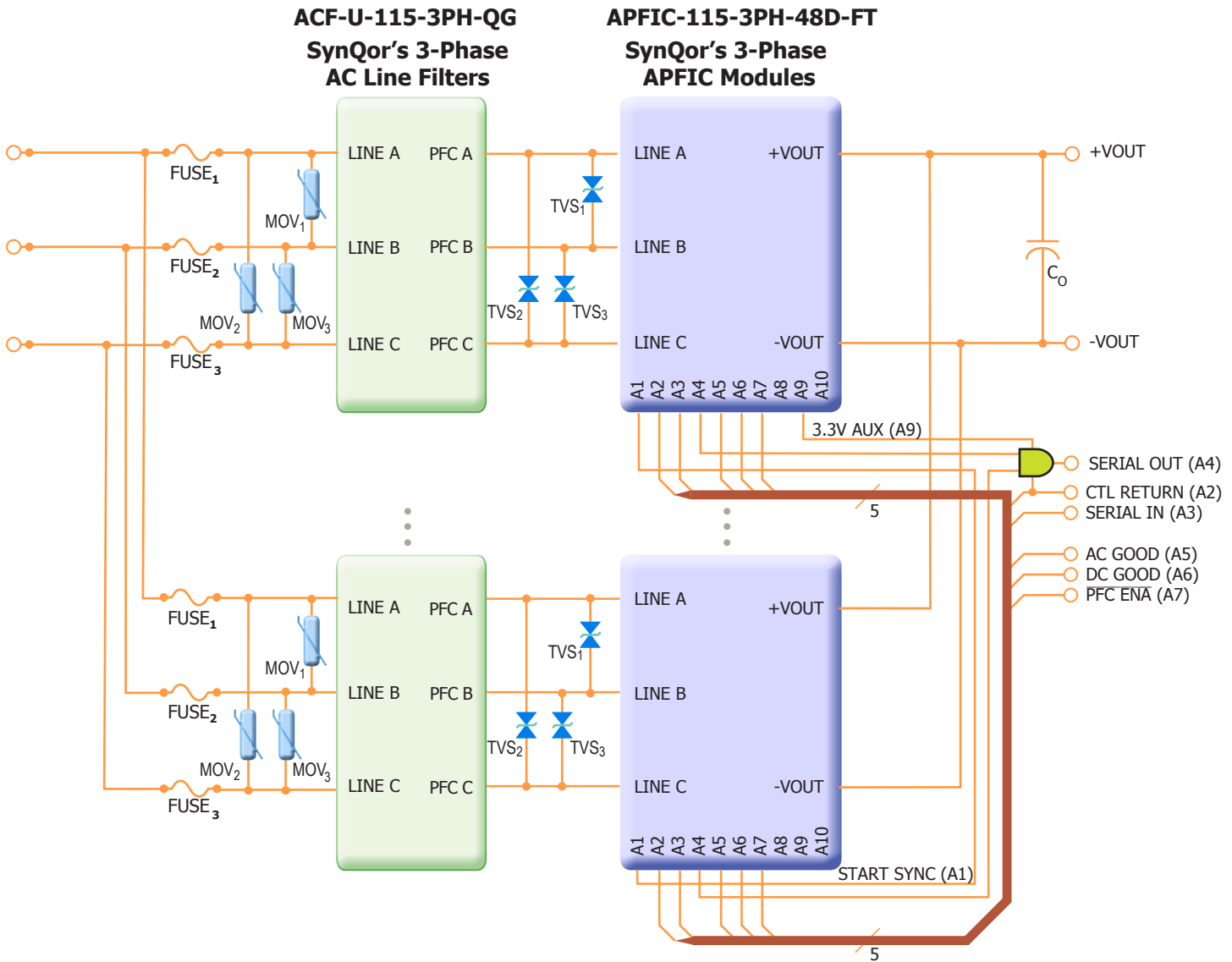

Suggested Parts:

MOV ₁₋₃ :	300 Vrms, 60 J; EPCOS S10K300E2
TVS ₁₋₃ :	430 Vpk, 20 J; Littelfuse AK3-430C or Bourns PTVS-430C-TH
Fuse ₁₋₃ :	250 Vrms, 10 A; Littelfuse 0216010.XEP

Figure B: Typical application with multiple APFIC-115-3PH-48D-FT AeroQor Isolated PFC modules wired in parallel



APFIC-115-3PH-48x-FT
Input: 115Vrms_{L-N} 3Φ
Output: 48 Vdc
Power: 720 W

Technical Specification

APFIC-115-3PH-48x-FT Electrical Characteristics

Operating Conditions: 115 Vrms L-N (199 Vrms L-L) 3-Phase 400 Hz; 720W output; baseplate temperature 25 °C; output capacitance 0.69mF unless otherwise noted. Full operating baseplate temperature range is -40 °C to +100 °C. Specifications subject to change without notice.

Parameter	Min.	Typ.	Max.	Units	Notes & Conditions
ABSOLUTE MAXIMUM RATINGS					
Input Voltage			575	Vpk L-L	Differential across any two line inputs
SERIAL IN and PFC ENA inputs	-2		7	V	Relative to CTL RETURN pin
AC GOOD, DC GOOD, and WARN outputs					
Pull Up Voltage	-2		7	V	Relative to CTL RETURN pin
Sink Current			10	mA	
Operating Temperature	-40		100	°C	Baseplate temperature
Storage Temperature	-55		125	°C	
INPUT CHARACTERISTICS					
Input Voltage Range, Operating					See app section "Power Ratings"
Continuous	100		140	Vrms L-N	173 to 242 Vrms L-L
Transient (≤ 1 s)	60		180	Vrms L-N	104 to 312 Vrms L-L
Input Overvoltage Protection (Between any two line inputs)	485	500		Vpk L-L	Threshold levels guaranteed by design
Operating Input Frequency	45		800	Hz	
Source Inductance			2	mH	see app section "Holdup"
Recommended Operating Range with Line Imbalance					
Amplitude Imbalance			5	Vrms L-N	
Phase Imbalance			5	deg	
Thresholds for Phase Drop Warning & Shutdown					Warning causes WARN pin to go high
Amplitude Imbalance		37		Vrms L-N	0.25s shutdown delay
Phase Imbalance		18		deg	
Inrush of AC Input Current			5	A	Output cap is charged later during startup ramp
Power Factor		0.99			
Reactive Power (per phase)					See note 1. Scales with AC line frequency.
400 Hz, Zero load or Disabled;		45		VAR	Leading
400 Hz, Pout > 200 W		0		VAR	See app section "Reactive Power at Fundamental"
Total Harmonic Distortion of AC Input Current		1.5	2.5	%	Full load (see Figure 4 for data vs. load)
Enabled AC Input Power, No Load (sum of phases)					
400Hz		16		W	
60Hz		14		W	
Disabled AC Input Power (sum of phases)					
400Hz		6		W	
60Hz		4		W	
Input Current Imbalance			± 1	%	
Continuous Input Current (per phase)			3	Arms	Vin=100 Vrms L-N
ISOLATED OUTPUT CHARACTERISTICS					
Output Steady-State Voltage	47.5	48.0	48.5	V	Zero Load
Output Voltage Droop					
Regulated Model		0		V	Full Load, see Figure 9
Droop Model		-3.3		V	Full Load, see Figure 9
Operating Output Current Range	0		15	A	
Output Current Limit			21	A	
Output Steady-State Voltage Ripple			240	mVrms	With minimum +VOUT capacitance and balanced line
Recommended Output Capacitance	0.6		12.5	mF	Use R D for additional cap
Output Over-Voltage Limit Threshold (Full Temp Range)	52.8		67.2	V	Not tested, guaranteed by design
EFFICIENCY					
100% Load (750W)		92.0		%	400 Hz (0.3% higher at 60 Hz)
50% Load (375W)		92.5		%	400 Hz (0.5% higher at 60 Hz)
DYNAMIC CHARACTERISTICS					
Turn-On Transient					
Startup Delay Time		45		ms	From PFC ENA to 10% nominal VOUT, see Figure 18
Total Turn-On Time		500		ms	From PFC ENA to DC GOOD, see Figure 18
VOUT Overshoot			1	%	
Auto-Restart Time		1		s	See "Protection Features" in application section

Note 1: Includes contribution from ACF-U-115-3PH-QG EMI filter



APFIC-115-3PH-48x-FT
Input: 115Vrms_{L-N} 3Φ
Output: 48 Vdc
Power: 720 W

Technical Specification

APFIC-115-3PH-48x-FT Electrical Characteristics (continued)

Operating Conditions: 115 Vrms L-N (199 Vrms L-L) 3-Phase 400 Hz; 720W output; baseplate temperature 25 °C; output capacitance 0.69mF unless otherwise noted. Full operating baseplate temperature range is -40 °C to +100 °C. Specifications subject to change without notice.

Parameter	Min.	Typ.	Max.	Units	Notes & Conditions
FEATURE CHARACTERISTICS					
SERIAL IN					
Idle / Stop State Input Voltage	2.4			V	
Zero / Start State Input Voltage			0.8	V	
Internal Pull-Up Voltage		3.3		V	
Internal Pull-Up Resistance		10		kΩ	
SERIAL OUT					
Idle / Stop State Output Voltage	2.9	3.1		V	4 mA source current
Zero / Start State Output Voltage		0.2	0.4	V	4 mA sink current
AC GOOD (positive logic)					
Input Voltage Low Threshold	90	95	100	Vrms _{L-N}	AC GOOD low below this threshold
Input Voltage High Threshold	145	150	155	Vrms _{L-N}	AC GOOD low above this threshold
Hysteresis of Input Voltage Thresholds		1		Vrms _{L-N}	Raises low threshold and lowers high threshold
Line Frequency Low Threshold	43	45	47	Hz	AC GOOD low below this threshold
Line Frequency High Threshold	860	900	940	Hz	AC GOOD low above this threshold
Hysteresis of Line Frequency Thresholds		0		Hz	
Low State Output Voltage		0.2	0.4	V	2 mA sink current
Internal Pull-Up Voltage		3.3		V	
Internal Pull-Up Resistance		10		kΩ	
DC GOOD (positive logic)					
Rising threshold		43		V	DC Power Good output
Falling threshold		31		V	DC GOOD high above this threshold
Low State Output Voltage		0.2	0.4	V	DC GOOD low below this threshold
Internal Pull-Up Voltage		3.3		V	
Internal Pull-Up Resistance		10		kΩ	
PFC ENA (negative logic)					
Off State Input Voltage	2.4			V	PFC enable input (pull low to enable unit)
On State Input Voltage			0.8	V	
Internal Pull-Up Voltage		3.3		V	
Internal Pull-Up Resistance		10		kΩ	
WARN (positive logic)					
Low State Output Voltage		0.2	0.4	V	Output shutdown warning
Internal Pull-Up Voltage		3.3		V	2 mA sink current
Internal Pull-Up Resistance		10		kΩ	
3.3V AUX					
Output Voltage Range	3.19	3.3	3.43	V	3.3 V output always on regardless of PFC ENA state
Source Current			100	mA	Over line, load, temp, and life
SYNC OUT					
High State Output Voltage	2.9	3.1		V	Synchronization output at switching frequency
Low State Output Voltage		0.2	0.4	V	4 mA source current
Buck & Boost Switching Frequency	190	196.5	203	kHz	4 mA sink current
ISOLATION CHARACTERISTICS					
Any pin to Baseplate					
Pins 2, 3, & 4 to Pins 7 & 9			2150	Vdc	Basic Isolation
Pins 2, 3, & 4 to Isolated Control Pins			4250	Vdc	Reinforced Isolation
Capacitance					
Pins 2, 3, & 4 to Baseplate		1		nF	
Pins 2, 3, & 4 to Pins 7 & 9		1		nF	
Isolation Resistance					
		100		MΩ	
TEMPERATURE LIMITS FOR POWER DERATING CURVES					
Semiconductor Junction Temperature			125	°C	
Board Temperature			125	°C	
Transformer Temperature			125	°C	
Maximum Baseplate Temperature, Tb			100	°C	
Over-Temperature Protection					
Disable Threshold		125		°C	Measured at surface of internal PCB
Warning Threshold		120		°C	Warning causes WARN pin to go high
Enable Threshold		120		°C	
RELIABILITY CHARACTERISTICS					
Calculated MTBF per Telcordia SR-332, Issue 2		584		kHrs.	Ground Benign, Tb = 70 °C
Calculated MTBF per MIL-HDBK-217F		549		kHrs.	Ground Benign, Tb = 70 °C
Calculated MTBF per MIL-HDBK-217F		61		kHrs.	Airborne Inhabited Cargo, Tb = 70 °C



APFIC-115-3PH-48x-FT
Input: 115Vrms_{LN} 3Φ
Output: 48 Vdc
Power: 720 W

Standards & Qualification

Parameter	Notes & Conditions
STANDARDS COMPLIANCE	
CE Marked	

Note: An external input fuse must always be used to meet these safety requirements. Contact SynQor for official safety certificates on new releases or download from the SynQor website.

Parameter	# Units	Test Conditions
QUALIFICATION TESTING		
Cold Temperature - Ground Survival	5	RTCA/DO-160G Section 4.5.1
Hot Temperature - Ground Survival	5	RTCA/DO-160G Section 4.5.3
Cold Temperature - Operating	5	RTCA/DO-160G Section 4.5.2
Hot Temperature - Operating	5	RTCA/DO-160G Section 4.5.4
Temperature Variation	5	RTCA/DO-160G Section 5.3.1
Temperature Cycling	5	MIL-STD-810G Method 503.5 – Procedure I
Humidity	3	RTCA/DO-160G Section 6.3.1 (Category A)
Waterproofness - Condensing	3	RTCA/DO-160G Section 10.3.1 (Category Y)
Fungus Resistance	1	MIL-STD-810G Method 508.6
Vibration - Fixed Wing and Helicopter	5	RTCA/DO-160G Sections 8.5.2 (Level B4), 8.8.3 (Levels G and F1)
Operational Shock and Crash Safety	5	RTCA/DO-160G Section 7.2.1, 7.3.1, and 7.3.3 (Category B)
Altitude - Steady State	2	RTCA/DO-160G Section 4.6.1; 70,000 ft (21 km), see note
Altitude - Decompression	2	RTCA/DO-160G Section 4.6.2
Design Marginality	5	Tmin-10 °C to Tmax+10 °C, 5 °C steps, Vin = min to max, 0-105% load
Life Test	5	95% rated Vin and load, units at derating point, 1000 hours
Solderability	15 pins	MIL-STD-883, Method 2003

Note: A conductive cooling design is generally needed for high altitude applications because of naturally poor convection cooling at rare atmospheres.

Category Description	3-Phase 115Vrms Specification Compliance
Input Voltage	787B3-0147, D6-44588, Airbus ABD0100.1.8, RTCA/DO-160G
AC Current Inrush	RTCA/DO-160G 16.7.5
Switching Transients	787B3-0147, D6-44588, Airbus ABD0100.1.8, RTCA/DO-160G, EN61000-4-4, EN61000-4-5
Voltage Spikes	787B3-0147, D6-44588, Airbus ABD0100.1.8, RTCA/DO-160G, EN61000-4-6
Frequency Transients	787B3-0147, D6-44588, Airbus ABD0100.1.8, RTCA/DO-160G
Harmonic Content	787B3-0147, D6-44588, Airbus ABD0100.1.8, RTCA/DO-160G, EN61000-3-2, MIL-STD-1399
DC Content on Input Voltage	787B3-0147, D6-44588, Airbus ABD0100.1.8, RTCA/DO-160G
Audio Frequency Conducted Susceptibility	D6-36440, RTCA/DO-160G
Audio Frequency Conducted Emissions	D6-36440, RTCA/DO-160G
Induced Signal Susceptibility	D6-36440, RTCA/DO-160G, EN61000-4-6
Conducted Emissions	D6-36440, RTCA/DO-160G, EN55011/22
Magnetic Effect	D6-36440, RTCA/DO-160G, EN61000-4-11
Radiated Emissions	D6-36440, RTCA/DO-160G, EN61000-4-3
Electrostatic Discharge	D6-36440, RTCA/DO-160G, EN61000-4-2
Electrical Bonding and Grounding	D6-36440, D6-44588, UL 60950-1
Lightning Susceptibility	D6-36440, D6-16050-5, RTCA/DO-160G
Reliability	Telcordia, MIL-HDBK-217F

POWER TOPOLOGY OVERVIEW

As seen in Figure A on page 2, this PFC rectifier takes nominal 115 Vrms (L-N) / 199 Vrms (L-L) 3-Phase delta AC at its LINE A/B/C inputs, and uses an active-PFC buck converter and a Bus Converter to create a regulated isolated DC output. This is a true 3-Phase rectifier topology, as opposed to a composite of three single-phase rectifiers. A boost converter between the active PFC and the bus converter's input supports the

output during input line sags and brownouts.

The term "line-to-neutral (L-N) voltage" is used in this document even though this converter does not utilize a neutral wire. If a neutral wire is present in the application, it should not be connected to the PFC.

PERFORMANCE

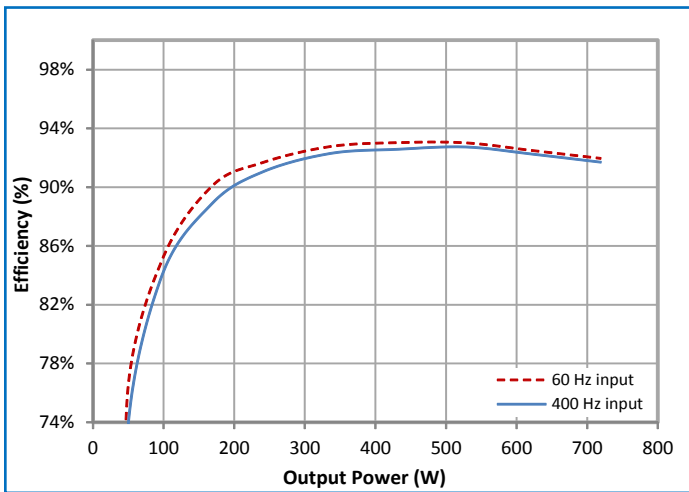

Figure 1: Efficiency vs. output power. Input: 3-Phase 115 Vrms (L-N). Baseplate temperature: 30 °C

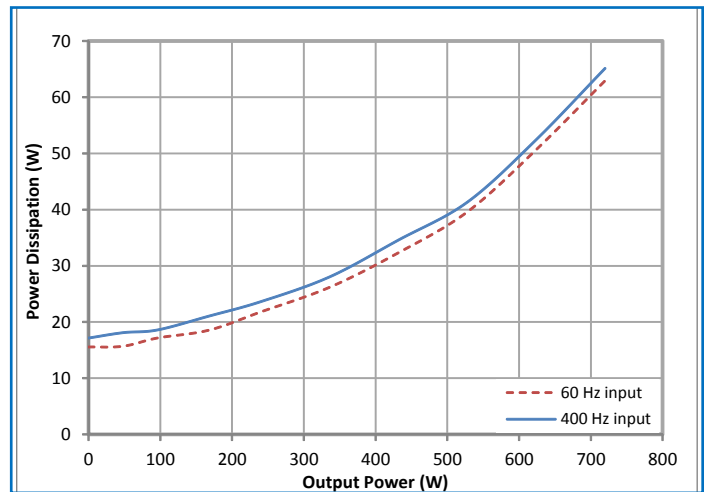

Figure 2: Power dissipation vs. output power. Input: 3-Phase 115 Vrms (L-N). Baseplate temperature: 30 °C.

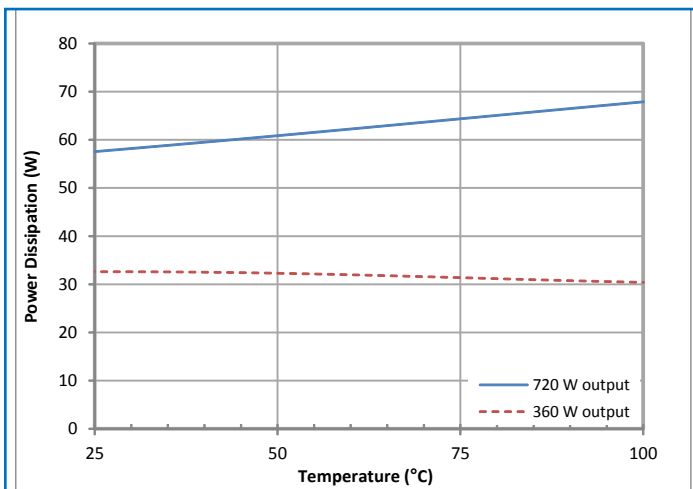

Figure 3: Power dissipation vs. baseplate temperature. Load applied at +VOUT. Input: 400 Hz 3-Phase 115 Vrms (L-N).

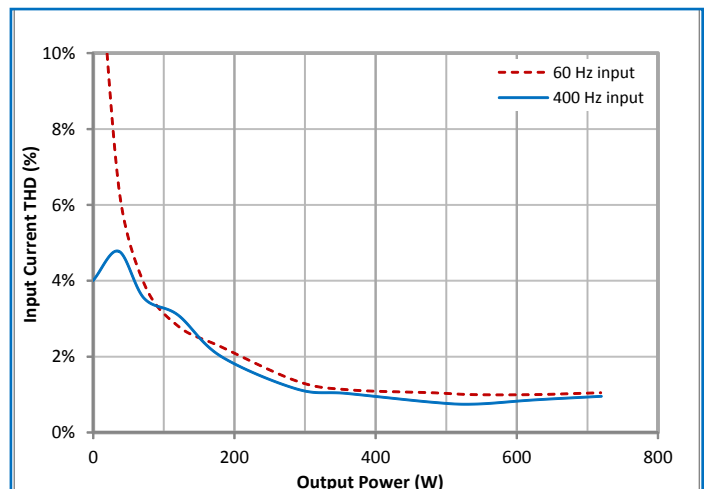

Figure 4: Input Current THD over full load range at 115 Vrms (L-N). Includes external input filter module, part number ACF-U-115-3PH-QG

Efficiency and Power Dissipation

The efficiency of the converter at 115VAC is shown in Figure 1, the corresponding power dissipation is shown in Figure 2, and variance over temperature is shown in Figure 3.

Input Current Distortion

Legacy diode rectifier solutions typically use bulky magnetics, while having relatively high distortion at line harmonics. In contrast, this modern PFC rectifier switches at high frequency, providing for very low distortion while using small and light internal magnetics. Active current control yields low harmonic content and well-balanced phase currents, even with phase and/or amplitude imbalance on the line inputs.

Input current harmonic content is minimal above 25% of full rated output power, increasing somewhat at light loads due to buck converter discontinuous mode operation (see Figure 4). Input current THD will increase with higher input voltage.

Reactive Power at Fundamental

Line capacitance is necessarily integral to the input EMI filter circuitry, which is divided between internal filtering and the external ACF-U-115-3PH-QG input filter module. Total leading reactive power (including that of the external input filter module) is approximately 45 VAR per phase at 400 Hz. At all but light loads, however, the PFC actively draws currents that lag input voltage slightly – to cancel the VAR of all the input filter capacitors. This can be seen directly in Figure 5, where, even at 400Hz, at 25% load and above, the input current is completely in phase with the applied input voltage. Only below 25% load is the leading current due to the filter capacitors seen. Figure 6 shows leading power factor as a function of output power at both 60Hz and 400Hz.

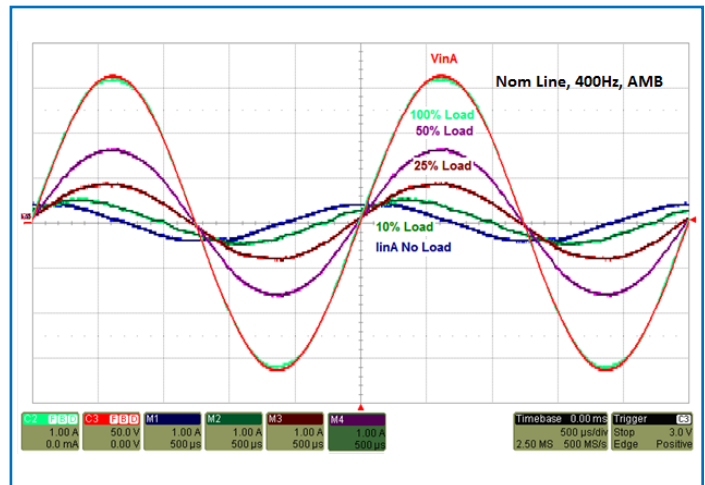

Figure 5: Typical 400 Hz input current waveforms (only Phase A shown); includes ACF-U-115-3PH-QG external input filter module.

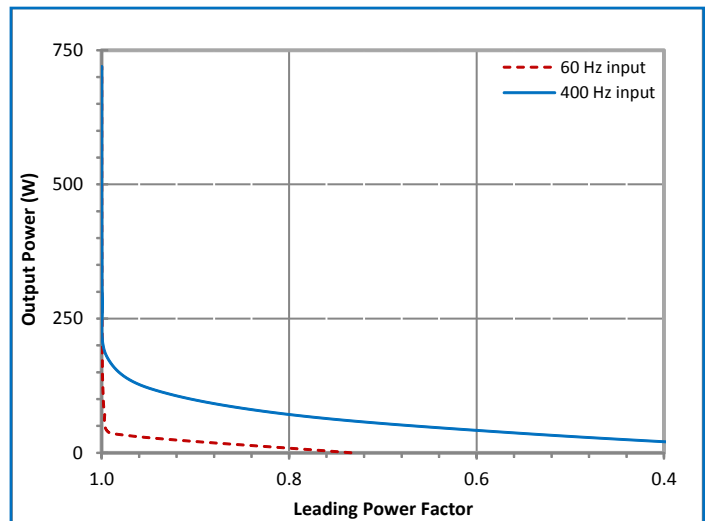

Figure 6: Input leading power factor as a function of operating power level; includes ACF-U-115-3PH-QG external input filter module.

POWER CIRCUITRY OVERVIEW

Inrush and Startup

Only a small amount of EMI capacitance resides before the main switches. The PFC buck topology affords excellent control over startup current. Even very large holdup capacitors can be charged gracefully with an actively controlled current limit (see Figure 7).

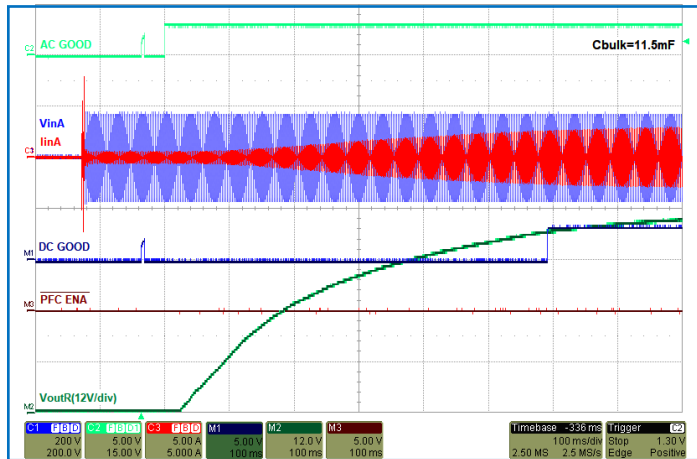

Figure 7: Full-Load (Resistive) Startup into 11.5mF (for clarity, only Phase A of the input voltage and current are shown).

Startup will only proceed after the AC GOOD signal is high. The unit will turn on when all three of the following conditions are met:

- 1) the PFC.ENA pin is pulled low
- 2) the input voltage is 100 Vrms (L-N) - 140 Vrms (L-N)
- 3) the input frequency is 45 Hz - 800 Hz

Line Transients

The input stage blocks even severe line transients from reaching the output, allowing generous headroom above typical operating input voltage levels.

Line Frequency and Phase Rotation

The PFC does not use an internal phase-locked loop, allowing seamless fast input frequency transients over the full 45 Hz - 800 Hz operating range.

The unit operates equally well with either ABC or CBA input voltage phase rotation.

AC Line Brownouts

The PFC can regulate its output indefinitely over the continuous operating range of $100 < V_{in} < 140$ Vrms. When V_{in} dips below 100 Vrms, an internal boost converter runs briefly to keep the output in regulation. The boost can run for a few seconds (the actual time is determined by line voltage, load, and temperature) after which it is disabled and the output voltage falls to the steady-state value. This behavior is illustrated in Figure 8.

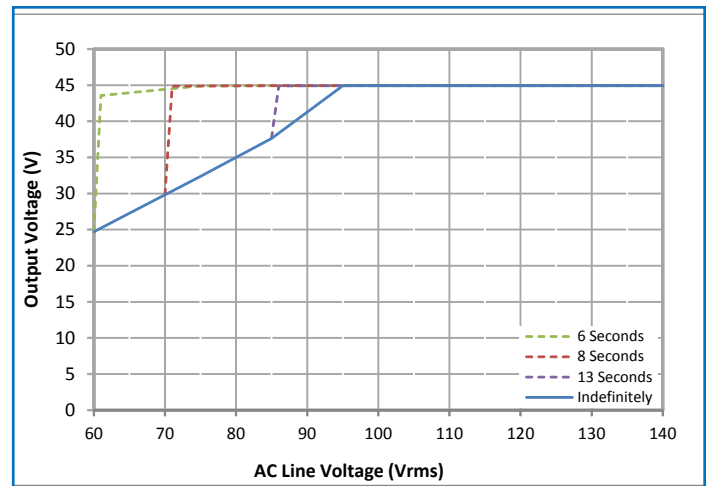

Figure 8: Full Load Output Voltage (Droop model) during Line Brownouts.

VOUT Regulation and Droop

The APFIC-115-3PH-48x-FT converter is available with two output voltage control choices: Regulated (x=R), and Droop (x=D). The regulated model is intended for standalone applications where tight control of the nominal voltage is desired. The Droop model is intended for sharing applications. In both, the output is tightly regulated at no-load, but in the droop model, the output voltage is programmed to decrease with increased load current (see Figure 9).

To maintain low distortion and harmonic content of the input currents, however, the regulation response of both models is intentionally quite slow; the recovery time constant from load transient is about 100ms. Higher-speed load transients must be handled by output capacitance and downstream converters. Figure 10 illustrates the device's load transient responses.

Reverse Power Flow

Because each switch in the PFC Rectifier is connected in series with a high-voltage diode, reverse powerflow (from the device's output back into the AC input)

is prevented. This protection exists in all modes of operation: disabled, starting up, operating, and shutting down – and it allows PFC units to be paralleled without concern for backdrive or circulation currents.

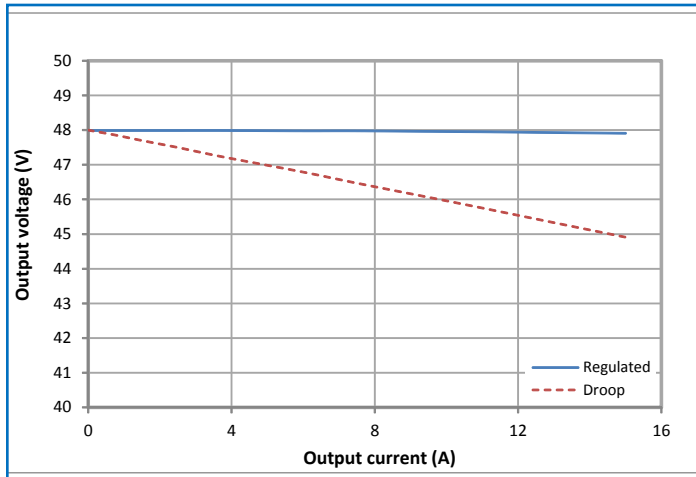

Figure 9: Steady-State Output Voltage vs. Output Current characteristics for both Regulated and Controlled Droop models.

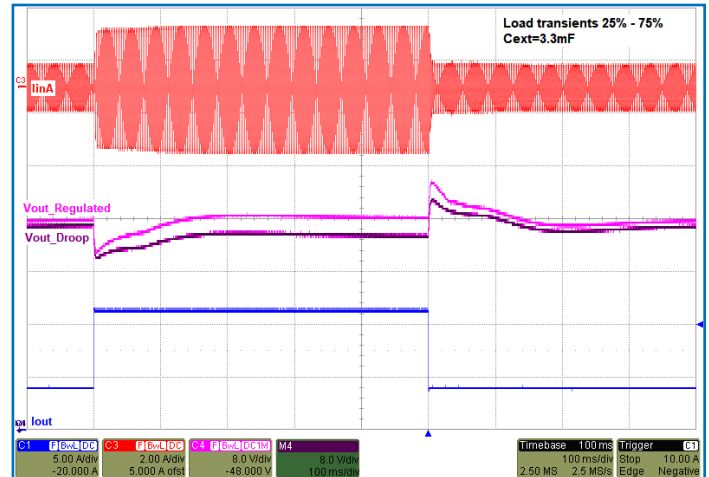

Figure 10: Responses to 25%-75%-25% Load Transient Steps: $C_{ext}=3.3mF$, both Regulated and Droop models.

POWER RATINGS

Thermal Management

Advanced thermal management techniques are employed to create a very low thermal resistance from power devices to baseplate, while retaining SynQor's standard SMT construction and mechanically compliant potting compound. At 720 W load, internal power devices run at about 20 °C above the baseplate temperature. This makes full rated power available even at a baseplate temperature of 100 °C.

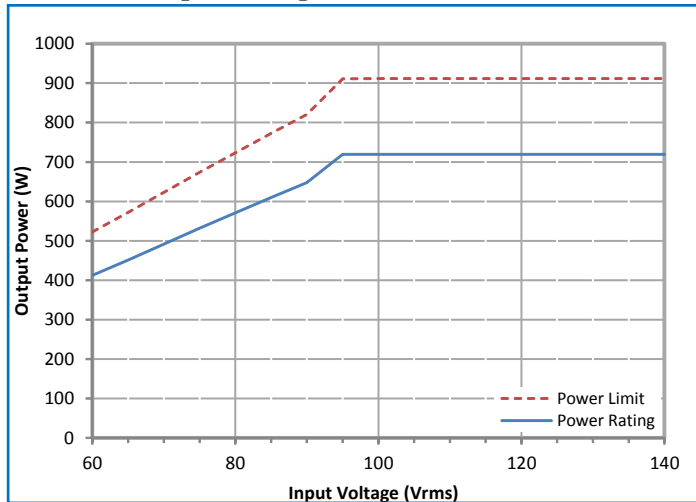

Figure 11: Steady-state rated and limit output power vs. AC line voltage.

Continuous Power Rating

Steady-state output power is rated to 720 W for input line voltages above 100 Vrms (L-N). This is based on a rated output current of 15 A, providing design margin against the (maximum) 21 A current limit specification. As the steady-state output voltage is reduced for input line voltages below 100 Vrms (see Figure 8), the current rating and limits remain constant. Thus, the power rating is reduced proportionately as shown in Figure 11.

Note that if the PFC output is driving DC-DC converters that exhibit constant-power characteristic at their inputs, the output voltage will collapse if the PFC's current limit is reached. The collapse rate would be governed by the external output capacitance value. It is therefore recommended to operate the converter at or below rated power in steady state, approaching current limit only during transient events.



Application Section

APFIC-115-3PH-48x-FT
Input: 115Vrms_{L-N} 3Φ
Output: 48 Vdc
Power: 720 W

PROTECTION FEATURES

Over-Temperature Shutdown

An internal sensor monitors the temperature of the PFC's PCB. If the sensor value exceeds 115 °C the WARN pin is asserted; if it exceeds 125 °C the unit will disable itself. At full-rated power this corresponds to a baseplate temperature of ≈ 110 °C (higher at reduced load). When the internal temperature cools below 115 °C, WARN is de-asserted and the PFC restarts automatically.

Input Phase Imbalance Shutdown

If the 3-phase AC input voltage should become excessively imbalanced (more than 35 Vrms amplitude or 18° angle imbalance), AC GOOD will be de-asserted and WARN will be asserted. Input phase drop events also appear as excessive imbalance. The PFC will attempt to maintain powerflow during this imbalance for 0.25 seconds before shutting down to protect itself, the load, and/or the source. The PFC will restart automatically when the AC line voltage returns to normal limits.

Short Circuit Current Limit

In most overload conditions, the linear output current limit is sufficient to protect the unit. A backup "short-circuit current limit" circuit, however, handles severe input transients or output short-circuit events. Redundant current sense resistors and comparators are connected in series with both the positive and negative sides of the buck PFC stage, set to trip well above the linear current limit threshold. When this backup protection is activated, the unit will respond by turning off all power flow from the input for approximately 200 μ s, after which normal operation resumes immediately.

Input Over-Voltage Protection

If the instantaneous voltage between any two-line inputs goes above the threshold of 500 V (L-L), then all power flow from the input will be interrupted, resuming 1 ms after the input voltage falls again below the same threshold. (Voltage spikes shorter than 80 μ s may not trigger this protection response.) During an interruption, the output voltage will fall at a rate determined by capacitance and load current.

Input Under Voltage Lockout/Shutdown

The input voltage must be above 100 Vrms (L-N) to activate AC GOOD and allow the unit to start up. If the input voltage subsequently drops below 50 Vrms (L-N) for more than 1 second the unit will shut down. The unit will stay off for at least 1 second.

Output Over-Voltage Protection

A redundant hardware over-voltage protection circuit will momentarily disable the PFC if the output ever rises more than 10% above its nominal value. The unit resumes normal operation immediately after the output voltage returns below this threshold.

Output Under-Voltage Shutdown

Should the action of the current limit reduce the output voltage to less than 25% of nominal for more than 150 ms, the unit will assume a sustained overload and will shut down. Auto-restart will occur after 1 second. This feature is also present during startup and thus serves to limit energy delivered into a shorted output.

EMI RECOMMENDATIONS

Input Filtering

As shown in Figure A, it is recommended (although not required) to pair the PFC module with the separately available ACF-U-115-3PH-QG quarter-brick 3-Phase AC input filter module.

Conducted Emissions Measurements

The APFIC-115-3PH-28R-FT, 28 V PFIC module paired with an ACF-U-115-3PH-QG, 3-Phase AC input line filter was demonstrated to pass DO-160 conducted emissions requirements as part of testing at an independent laboratory. Key measurements are presented in Figures 12 to 14; the full test report is available from SynQor.

Input Protection

The input stage implemented in this module offers far better immunity from input surges than a traditional boost topology. In a traditional boost PFC, there is no mechanism to limit current flow directly from input to output during operation, so for long duration surges, the current becomes very large and results in permanent destruction. In contrast, the buck PFC input stage used in this module is able to interrupt current flow during a voltage surge which dramatically lowers device stresses.

The PFC input lines must be protected from spikes which might exceed their 575 Vpk (L-L) absolute-maximum rating. It is recommended to add external protection devices directly between the three pairs of PFC line input pins. Figure A shows an example input protection circuit consisting of clamping devices connected line-line in a “delta” configuration, one set before and one set after the external ACF-U-115-3PH-QG input filter module. The set of Metal Oxide Varistors (MOVs) upstream of the filter prevent local arcing during a surge event due to input wiring inductance. These MOVs have a “soft” breakdown characteristic: at high currents they will clamp at a relatively high voltage. The set of special TVS devices downstream of the filter module have far superior characteristics. These AK3-430C devices made by Littelfuse (or equivalent Bourns PTVS-430C-TH) have superb clamping voltage: even at high currents they hold the input voltage below the 575 Vpk (L-L) absolute maximum specification of the PFC module. These devices also have high energy capability: whereas standard TVS devices have a relatively small die, the AK3 series parts have many large dies stacked on top of each other. This allows the AK3 to withstand very high energy repetitive

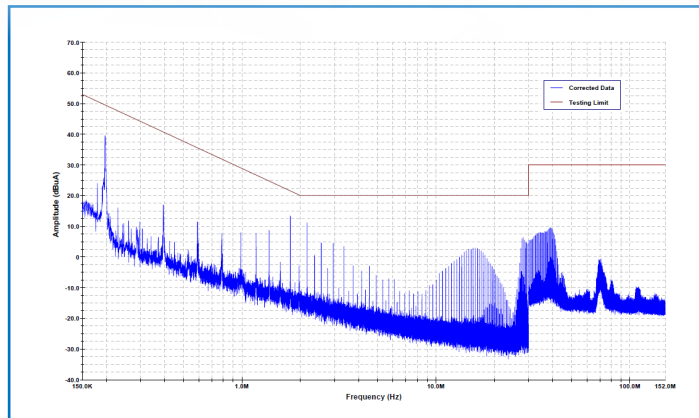

Figure 12: Conducted Emissions at 400 Hz, 750 W output power (Phase A)

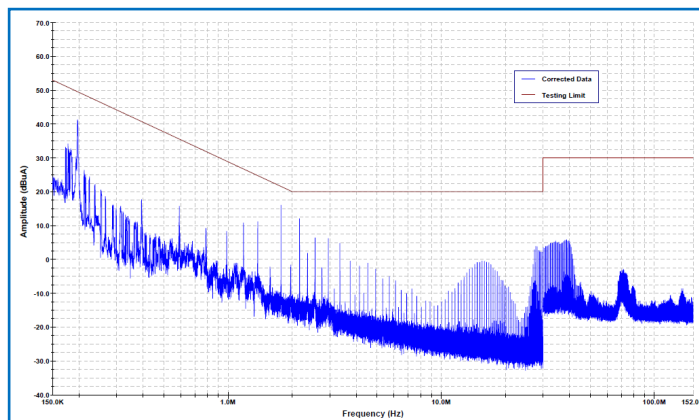

Figure 13: Conducted Emissions at 400 Hz, 750 W output power (Phase B)

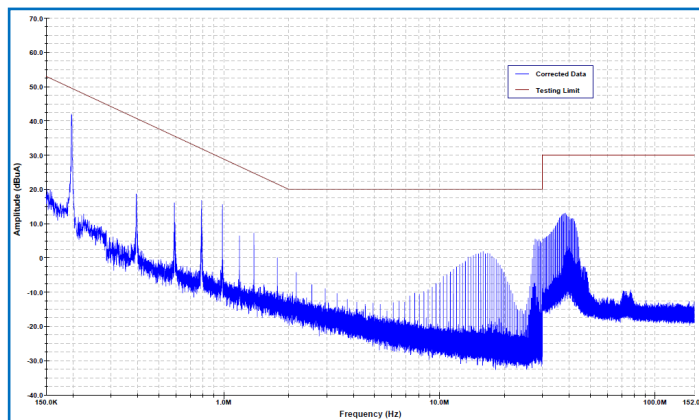

Figure 14: Conducted Emissions at 400 Hz, 750 W output power (Phase C)

transients without damage. Protection devices in the end user application should be tailored to the expected surge requirements. Fuses rated for 10 A are recommended in series with each input line, located upstream of the MOVs.

Baseplate Electrical Connection

All circuitry in the PFC module is electrically isolated from the baseplate with a multi-layer solid insulator. This isolation barrier meets basic insulation requirements and is 100% hi-pot tested in production to 1500 Vrms. The baseplate and corner mounting posts may therefore be connected to protective earth ground in the application circuit. Maintain adequate clearance from all external circuitry to the four corner mounting posts, which are electrically connected to the baseplate.

Safety Notes

The APFIC provides reinforced isolation across its input and output terminal pins. Care must be taken to avoid contact with primary-side voltages, as well as with the AC source voltage.

The APFIC must have a current limiting device. The Technical Application diagrams show fuses used in series with the AC source.

CONTROL PINS

START SYNC (Pin A1)

The START SYNC pin should be left floating (no connect) in single-unit / standalone applications. In paralleled applications, connect START SYNC between multiple units to synchronize restart after a fault condition. Internal interface circuitry is shown in Figure 15.

CTL RETURN (Pin A2)

CTL RETURN serves as the ground reference for all control signals. 3 kV of reinforced isolation is provided between all control pins and the power pins. CTL RETURN may be externally connected to any of the power pins, attached to an application circuit, or left floating.

SERIAL IN (Pin A3)

A wide variety of operating parameters (voltages, currents, temperatures) may be accessed via the built-in full-duplex asynchronous serial interface. Commands may

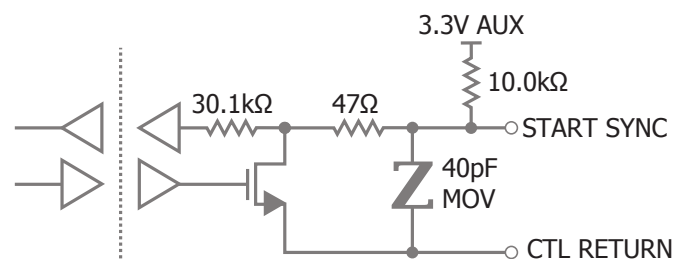

Figure 15: Internal circuitry for START SYNC pin.

be transferred to the internal DSP via the SERIAL IN pin at 9600 baud (8N1 – 8 data bits, no parity, 1 stop bit). A 'start' or 'zero' bit is encoded as a logic low. The internal baud rate will be exactly 20.48 times slower than the SYNC OUT frequency. The tolerance of both frequencies is better than +/- 2%. The frequency tolerance of the external interface circuit should also be better than +/- 2% accuracy to ensure that the last bit of incoming serial data arrives within the proper frame time. Alternatively, the SYNC OUT signal may be used to continuously calibrate the baud rate of the external interface circuit, allowing the use of a less accurate oscillator.

The SERIAL IN pin may be left open if unused, and will be internally pulled up to 3.3V AUX, corresponding to the 'idle' or 'stop' state. Internal circuitry is shown in Figure 16. Direct connection may be made to an external micro-controller, but an external transceiver IC is required to shift levels and polarity to drive from a standard RS-232 port (see evaluation board schematic). See the separate "SynQor 3-Phase Input PFC Serial Interface" companion document for detailed command syntax (available at: www.synqor.com/3-Phase_Input_PFC_Serial_Interface).

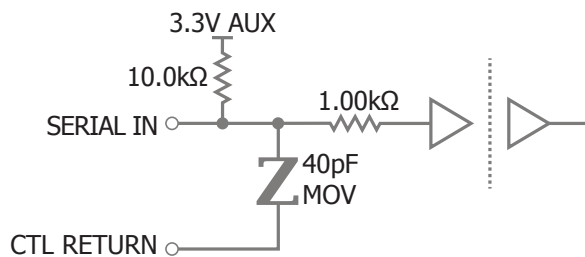

Figure 16: Internal circuitry for SERIAL IN pin.

SERIAL OUT (Pin A4)

A response to each command is sent via the SERIAL OUT pin at 9600 baud (8N1 – 8 data bits, no parity, 1 stop bit). The output is low for a 'start' or 'zero' bit. When not transmitting, the output is high, corresponding to the 'idle' or 'stop' state. Internal circuitry is shown in Figure 20. Direct connection may be made to an external micro-controller, but an external transceiver IC is required to shift levels and polarity to drive a standard RS-232 port (see evaluation board schematic). See the separate "SynQor 3-Phase Input PFC Serial Interface" companion document for detailed response syntax (available at: www.synqor.com/3-Phase_Input_PFC_Serial_Interface).

AC GOOD (Pin A5)

The unit will not turn on until the positive-logic AC GOOD output is high, typically for line inputs between 96 Vrms (L-N) and 148 Vrms (L-N). When the unit is already running, the AC GOOD output will typically transition low when the input voltage (at the PFC input pins) goes below 95 Vrms (L-N) or above 149 Vrms (L-N). Instantaneous line to line voltage measurements are used, so these voltage thresholds will be affected by imbalance in line phase and/or amplitude.

AC GOOD also responds to input line frequency. If the input line frequency goes below 45 Hz or above 900 Hz, AC GOOD will transition low.

AC GOOD generally only serves as a power interruption warning: the unit will continue to run if AC GOOD transitions low, the only exception being an excessive input phase imbalance. During the imbalance, the PFC will attempt to maintain powerflow for 0.25 seconds before shutting down to protect itself, the load, and/or the source.

The response time of AC GOOD to an input power interruption is less than 1 ms at 400 Hz and less than 5 ms at 60 Hz. AC GOOD will return to its normal high state 20 ms after the line voltage recovers. Internal interface circuitry is shown in Figure 17.

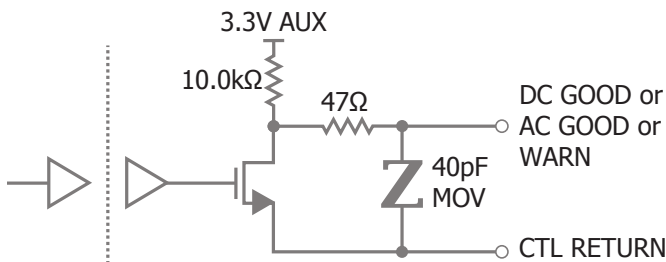

Figure 17: Internal circuitry for DC GOOD, AC GOOD and WARN pins.

DC GOOD (Pin A6)

During startup the positive-logic DC GOOD output will remain low until +VOUT crosses the rising threshold value (see Figure 18). The falling threshold is significantly lower, such that DC GOOD will usually remain high during an input power interruption. Therefore, DC GOOD is typically used to indicate successful startup, whereas AC GOOD is used to warn of an input power interruption. The typical DC GOOD response time is less than 1 ms. Internal interface circuitry is shown in Figure 17.

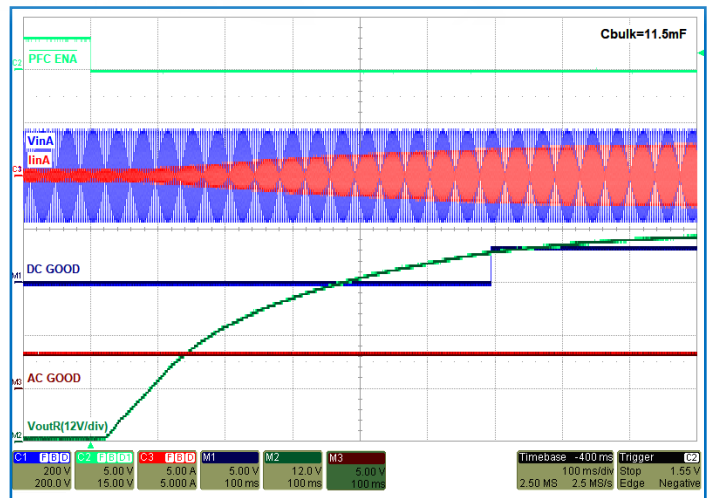

Figure 18: Timing from PFC ENA to startup; AC GOOD, DC GOOD, VinA and IinA also shown for reference.

PFC ENA (Pin A7)

The PFC ENA pin must be brought low to enable the unit. A 10.0 kΩ pull-up resistor is connected internally to 3.3V AUX. Therefore, if all control pins are left floating, the unit will be disabled. The delay from enable to the beginning of the startup ramp is typically 30 ms (see Figure 18). Internal interface circuitry is shown in Figure 19.

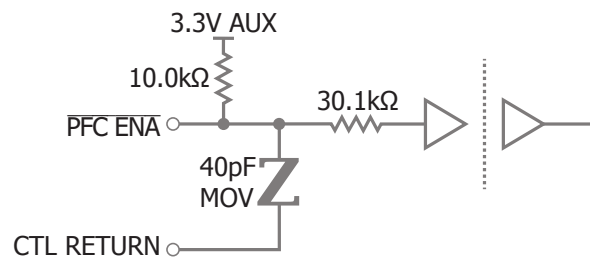

Figure 19: Internal circuitry for PFC ENA pin.

WARN (Pin A8)

If the WARN pin is not externally held low, the pin will go high to warn of either an impending over-temperature shutdown or an input phase drop shutdown. The over-temperature warning engages 5 °C below shutdown. The input phase drop warning engages 250 ms before shutdown. A 10.0 kΩ pull-up resistor is connected internally to 3.3V AUX. Internal interface circuitry is shown in Figure 17.

3.3V AUX (Pin A9)

The 3.3V AUX supply (relative to CTL RETURN) can source up to 100 mA to power user loads. This independent supply is always energized whenever AC input voltage is present. In addition, during AC Line interruptions, this supply runs from energy stored in external bulk capacitance at VOUT (providing that the PFC was operating prior to the line interruption and that the voltage at VOUT remains >50% of nominal until AC power returns).

If unused, the 3.3V AUX output should be left open.

SYNC OUT (Pin A10)

The SYNC OUT pin generates a continuous series of pulses at the main switching frequency. The buck and boost converters are synchronized and switch at the same frequency. The SYNC OUT pin may be left open if not used. Internal interface circuitry is shown in Figure 20.

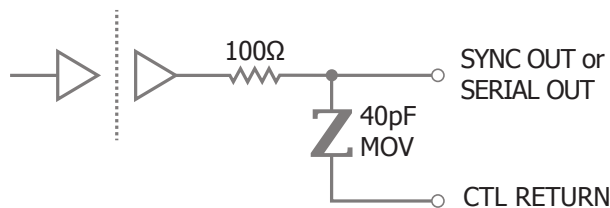

Figure 20: Internal circuitry for SYNC OUT and SERIAL OUT pins.

POWER INTERRUPTS & HOLDUP

Many systems need to operate through brief interruptions of AC input power. External capacitors placed at +VOUT can be used to maintain power flow to critical loads during these input power interruptions.

Holdup Capacitor Value

During a AC dropout of a given duration, the load is supplied from the bulk cap. The dropout is characterized by its energy.

$$E_{holdup} = P_{out} \cdot t_{drop}$$

where:

P_{out} is the output power during the holdup event

t_{drop} is the duration of the input power interruption

Based on this energy requirement, the holdup capacitor value is

$$C_{holdup} > \frac{2 \cdot E_{holdup}}{(V_s^2 - V_f^2)}$$

where:

V_s is the initial holdup capacitor voltage immediately before the input power interruption

V_f is the minimum capacitor voltage during the transient

V_f should be chosen to be above the minimum acceptable voltage for the loads attached.

The required value for C can become quite large if the PFC's entire load is to be maintained through long dropouts. In this case it may be valuable to partition the load into portions that need to be maintained and other portions that can be briefly interrupted.

External Capacitor Selection

Capacitors connected externally at +VOUT, the rating should be higher than the output voltage of the module used. Standard aluminum electrolytic capacitors have several significant drawbacks:

- 1) Narrow temperature ratings
- 2) Relatively high ESR at room temperature
- 3) Very high ESR at low temperature
- 4) Poor reliability at high temperature

Conductive polymer solid electrolytic capacitors solve all four of these problems at the expense of somewhat lower energy density:

- 1) Rated for full -55 °C to 125 °C temperature range
- 2) Good ESR at room temperature
- 3) Rated to maintain good ESR at low temperature
- 4) Much better reliability

PARALLELING GUIDELINES

The APFIC-115-3PH-48D-FT Droop Share option includes several control features to facilitate paralleling. Up to 10 units may be paralleled with outputs directly connected. A typical application schematic for direct paralleling is shown in Figure B. Current sharing is achieved via the output voltage droop characteristic shown in Figure 9. This sharing method is inherently simple and robust: it is distributed (no master/slave), and involves no communication between units. On startup, total load should not exceed the rating of a single module until all of the individual DC GOOD outputs have been asserted high.

Current Sharing Accuracy

The output voltage is controlled to vary significantly as a computed function of measured current (see Figure 9). The voltage offset and gain is factory calibrated to minimize unit- to-unit variation. This calibration process results in good sharing accuracy: the output power of each unit typically matches the average power to within +/- 50 W. External output wiring resistances should be matched between units for optimum sharing performance.

Power Connections for Paralleling

The following power wiring recommendations for a parallel system are captured in the typical application diagram in Figure B:

- 1) +VOUT and -VOUT may be wired directly in parallel.
- 2) The LINE A/B/C inputs should be wired in parallel upstream of their individual input filters. Do not wire individual EMI filters directly in parallel at both their inputs and their outputs.
- 3) Each PFC unit should have its own TVS bank located near the input pins.

Features for Paralleling (Droop)

Several special features are included to facilitate paralleling: When connected between multiple units, the START SYNC bus actively aligns the restart time between units following an event that causes units to enter hiccup-mode. For instance, when full load is applied, one or more units could experience over-temperature shutdown, causing the remaining units to engage current limit, and 50 ms later entering hiccup due to midbus under-voltage shutdown. When these units attempt to restart, they may not start because some units are still forced off due to high temperature and the remaining units cannot support full load. When all the units are cool enough to restart, the hiccup times between all units will probably not be aligned, so without START SYNC, the system may still not start. The START SYNC feature delays restart until all units are out of the hiccup state, so that all units will start up simultaneously. The “E” serial port command automatically assigns a unique “Net Address” to each unit in the system. All units must be disabled at the time this command is issued. Each unit has a unique 120-bit number stored in ROM, which is encoded onto the START SYNC bus during this enumeration process. The resulting assigned “Net Address” may be used with a shared serial port to communicate individually to each unit in a paralleled system. The “Net Address” reverts to the default value of ‘m’ when power is cycled, so the enumeration command should be part of the system boot sequence.

The “N” serial port command optionally overrides the state of the input, allowing a unit to be forced on or off.

The Battle-Short function may be set via the serial port using the “n” command.

Control Connections for Paralleling

The following are control signal wiring recommendations for a parallel system:

- The CTL RETURN pins from multiple units should be connected together to provide a common control ground.
- SERIAL IN and PFC ENA input pins may be wired in parallel.
- AC GOOD and DC GOOD output pins may be wired in parallel.
- START SYNC should be connected in parallel between all units in the system.
- The 3.3V AUX outputs could also be paralleled, but total current drawn from 3.3V AUX should not exceed the 100mA rating of a single unit.
- SYNC OUT pins should not be connected between units: doing so would cause a logic output contention.
- The SERIAL OUT signals may be combined using an external AND gate. Alternatively, a multi-drop bus may be formed by pulling the bus low when SERIAL OUT is low, and releasing the bus when SERIAL OUT is high, returning the bus to the idle state via a pull-up resistor. The time constant of this pull-up resistor along with any parasitic capacitance must be much shorter than the baud rate.
- If the WARN protection-warning output function is used in a paralleled system, then individual signals should be combined using an OR gate. If a WARN pin is not used, it may be left open.



Encased Mechanical

APFIC-115-3PH-48x-FT
Input: 115VrmsL-N 3Φ
Output: 48 Vdc
Power: 720 W

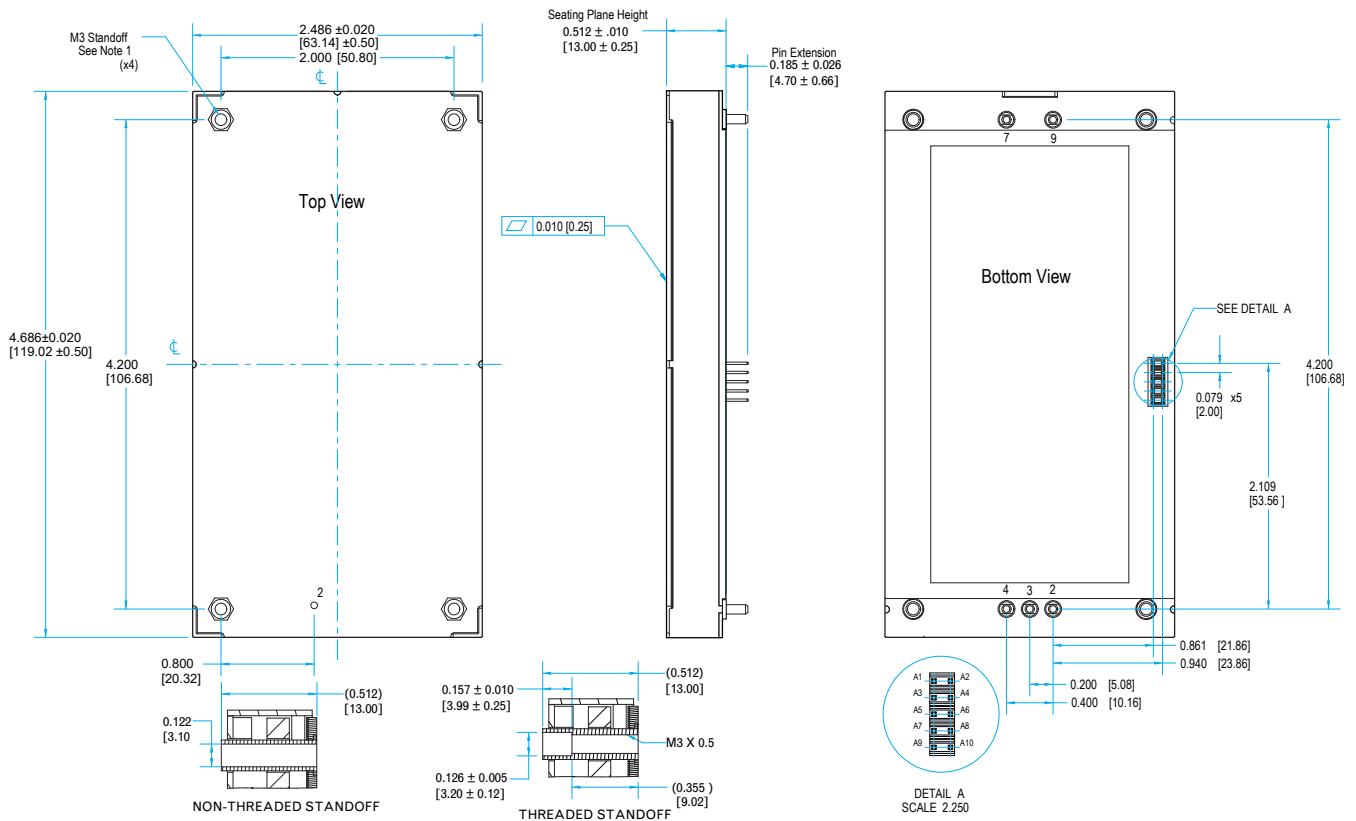

NOTES:

1. APPLIED TORQUE PER M3 SCREW SHOULD NOT EXCEED 6 in-lb (0.7 Nm)
2. BASEPLATE FLATNESS TOLERANCE IS 0.010" (0.25 mm) TIR FOR SURFACE.
3. PINS 2-4, AND 7, 9 ARE 0.080" (2.03 mm) DIA. WITH 0.125" (3.18 mm) DIA. STANDOFF SHOULDERS
MATERIAL: COPPER ALLOY. FINISH: MATTE TIN OVER NICKEL PLATE.
4. PINS A1-A10 ARE 0.020" X 0.020" (0.51mm X 0.51mm)
MATERIAL: PHOSPHOR BRONZE, FINISH: GOLD FLASH OVER NICKEL UNDERPLATING.
5. THREADED OR NON-THREADED OPTIONS AVAILABLE
6. UNDIMENSIONED COMPONENTS ONLY FOR VISUAL REFERENCE
7. ALL DIMENSIONS IN INCHES (mm)
TOLERANCES: X.XX IN +/-0.020 (X.X mm +/-0.5 mm)
X.XXX IN +/-0.010 (X.XX mm +/-0.25 mm)
8. WEIGHT: 11.3 oz (320 g)

PIN DESIGNATIONS

Pin	Label	Name	Function
2	LINE A	LINE A	AC Line A Input
3	LINE B	LINE B	AC Line B Input
4	LINE C	LINE C	AC Line C Input
7	-VOUT	VOUT(-)	Output Voltage, Negative
9	+VOUT	VOUT(+)	Output Voltage, Positive
A1	START SYNC	START SYNC	Startup Synchronization (Droop Sharing)
A2	CTL RETURN	CTL RETURN	Isolated Ground Reference for Pins A1 - A10
A3	SERIAL IN	SERIAL IN	Serial Data Input (High = Stop/Idle)
A4	SERIAL OUT	SERIAL OUT	Serial Data Output (High = Stop/Idle)
A5	AC GOOD	AC GOOD	AC Power Good Output (High = Good)
A6	DC GOOD	DC GOOD	DC Power Good Output (High = Good)
A7	PFC ENA	PFC ENA	Pull Low to Enable Unit
A8	WARN	WARN	High when DUT is warning shutdown
A9	3.3V AUX	3.3V AUX	3.3V @ 100mA Always-On Power Output
A10	SYNC OUT	SYNC OUT	Switching Frequency Synchronization Output



APFIC-115-3PH-48x-FT
Input: 115VrmsL-N 3Φ
Output: 48 Vdc
Power: 720 W

Encased Mechanical with Flange

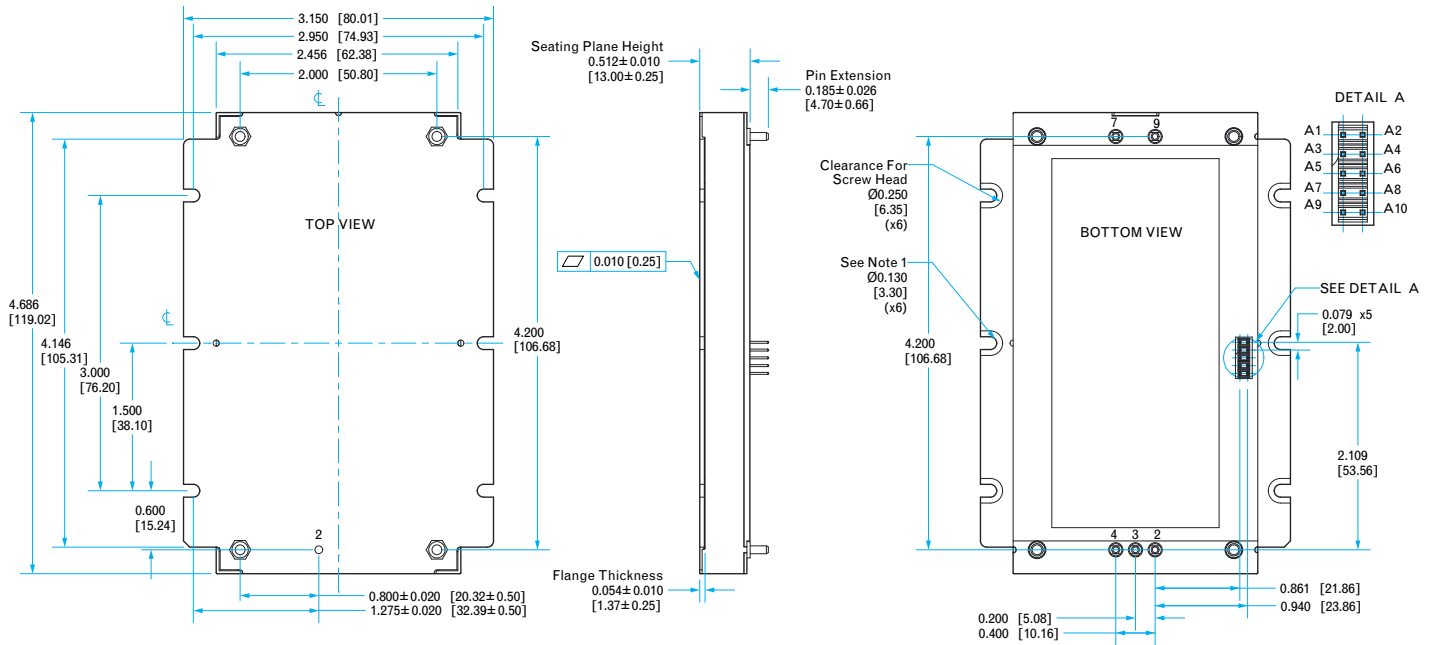

NOTES:

1. APPLIED TORQUE PER SCREW SHOULD NOT EXCEED 6 in-lb (0.7 Nm)
2. BASEPLATE FLATNESS TOLERANCE IS 0.010" (0.25 mm) TIR FOR SURFACE.
3. PINS 2-4 AND 7, 9 ARE 0.080" (2.03 mm) DIA. WITH 0.125" (3.18 mm) DIA. STANDOFF SHOULDERS.
MATERIAL: COPPER ALLOY. FINISH: MATTE TIN OVER NICKEL PLATE.
4. PINS A1-A10 ARE 0.020" X 0.020" (0.51mm X 0.51mm)
MATERIAL: PHOSPHOR BRONZE, FINISH: GOLD FLASH OVER NICKEL UNDERPLATING
5. UNDIMENSIONED COMPONENTS ONLY FOR VISUAL REFERENCE
6. ALL DIMENSIONS IN INCHES (mm)
TOLERANCES: X.XX IN +/-0.020 (X.X mm +/-0.5 mm)
X.XXX IN +/-0.010 (X.XX mm +/-0.25 mm)
7. WEIGHT: 11.6 oz (326 g)

PIN DESIGNATIONS

Pin	Label	Name	Function
2	LINE A	LINE A	AC Line A Input
3	LINE B	LINE B	AC Line B Input
4	LINE C	LINE C	AC Line C Input
7	-VOUT	VOUT(-)	Output Voltage, Negative
9	+VOUT	VOUT(+)	Output Voltage, Positive
A1	START SYNC	START SYNC	Startup Synchronization (Droop Sharing)
A2	CTL RETURN	CTL RETURN	Isolated Ground Reference for Pins A1 - A10
A3	SERIAL IN	SERIAL IN	Serial Data Input (High = Stop/Idle)
A4	SERIAL OUT	SERIAL OUT	Serial Data Output (High = Stop/Idle)
A5	AC GOOD	AC GOOD	AC Power Good Output (High = Good)
A6	DC GOOD	DC GOOD	DC Power Good Output (High = Good)
A7	PFC ENA	PFC ENA	Pull Low to Enable Unit
A8	WARN	WARN	High when DUT is warning shutdown
A9	3.3V AUX	3.3V AUX	3.3V @ 100mA Always-On Power Output
A10	SYNC OUT	SYNC OUT	Switching Frequency Synchronization Output



Ordering Information

APFIC-115-3PH-48x-FT
Input: 115Vrms_{L-N} 3Φ
Output: 48 Vdc
Power: 720 W

Part Numbering Scheme						
Family	Input Voltage	Output	Regulation	Package Size	Thermal Design	RoHS
APFIC	115-3PH: 115 Vrms 3Φ	12: 12V 24: 24V 28: 28V 48: 48V 54: 54V	R: Regulated Output D: Droop Sharing	FT: Full-brick Tera	C: Encased D: Encased with Non-threaded Baseplate V: Encased with Flanged Baseplate	G: RoHS

Example: APFIC-115-3PH-48D-FT-C-G
APFIC-115-3PH-48R-FT-D-G

RoHS Compliance: The EU led RoHS (Restriction of Hazardous Substances) Directive bans the use of Lead, Cadmium, Hexavalent Chromium, Mercury, Polybrominated Biphenyls (PBB), and Polybrominated Diphenyl Ether (PBDE) in Electrical and Electronic Equipment. This SynQor product is 6/6 RoHS compliant. For more information please refer to SynQor’s RoHS addendum available at our [RoHS Compliance / Lead Free Initiative web page](#) or e-mail us at rohs@synqor.com.

Validation, Verification & Certification

USA Manufacturing Facility: AS9100 & ISO 9001 Certified

SynQor considers in-house manufacturing to be a core competency and strategic advantage. All SynQor products are manufactured in our manufacturing facility at our corporate headquarters in Boxborough, MA, USA, utilizing state-of-the-art equipment and proprietary assembly techniques. By maintaining both AS9100 and ISO9001 certifications, SynQor is able to provide the same level of attention to detail in our manufacturing processes as we do in our products. We utilize proprietary in-house developed manufacturing data and document control systems that allow us to operate in a paperless manufacturing environment, providing both maximized manufacturing efficiency and flexibility. Ultimately, our manufacturing expertise remains in-house, allowing us to maintain complete control over the quality and traceability of our product down to the component level to meet the most stringent customer and industry requirements.

Design, Engineering & Manufacturing Process

SynQor employs a stringent, ECO controlled, 5-stage product development process, starting with product concept design and ending with manufacturing integration. We believe that a solid design and DFM review process leads to efficient manufacturing, higher performance, and enhanced reliability. By designing for reliability, SynQor greatly reduces the chance of field defects and increases product integrity.

Concept Design	Design & Verification	Proof of Design	Proof of Manufacturing	Manufacturing Integration
<ul style="list-style-type: none"> Generate electrical specification Review performance requirements Design simulation Schematic Qualify new components Breadboard Prelim thermal analysis 	<ul style="list-style-type: none"> Full layout DFM/DFT Review Build engineering prototypes Debug circuit Worst-case electrical testing Component stress analysis Stability analysis Abnormal electrical testing Specification review Preliminary datasheet 	<ul style="list-style-type: none"> Build units and electrically characterize Verify electrical performance Verify component stress analysis Statistical variations Thermal analysis and imaging HALT testing Complete datasheet 	<ul style="list-style-type: none"> Controlled Production Build ATE testing Yield analysis Validate and finalize manufacturing processes and Tooling 1000 hour life test Qualification testing (humidity, vibration, DMT, PTC, thermal and mechanical shock, altitude and solderability) 	<ul style="list-style-type: none"> Processes transfer Full documentation release (SCD’s, BOM, processes, procedures, etc.) Release qualification reports Release final datasheet Transfer units to finished goods

Contact SynQor for further information and to order:

Phone: 978-849-0600
Toll Free: 888-567-9596
Fax: 978-849-0602
E-mail: power@synqor.com
Web: www.synqor.com
Address: 155 Swanson Road
 Boxborough, MA 01719
 USA

PATENTS

SynQor holds numerous U.S. patents, one or more of which apply to most of its power conversion products. Any that apply to the product(s) listed in this document are identified by markings on the product(s) or on internal components of the product(s) in accordance with U.S. patent laws. SynQor’s patents include the following:

7,050,309 7,765,687 7,787,261
 8,149,597 8,644,027

WARRANTY

SynQor offers a two (2) year limited warranty. Complete warranty information is listed on our website or is available upon request from SynQor.